

Universal LED rotary dimming insert Komfort

Order no.: 2455 00

Operating instructions**1 Safety instructions**

Electrical devices may only be mounted and connected by electrically skilled persons.

Serious injuries, fire or property damage possible. Please read and follow manual fully.

Danger of electric shock. Always disconnect before carrying out work on the device or load.

Danger of electric shock. Device is not suitable for disconnection from supply voltage. The load is not electrically isolated from the mains even when the device is switched off.

Risk of destruction if the set operating mode and load type do not match. Set correct operating mode when connecting or exchanging the load.

Fire hazard. For operation with inductive transformers, each transformer must be fused on the primary side in accordance with the manufacturer's instructions. Only safety transformers according to EN 61558-2-6 may be used.

These instructions are an integral part of the product, and must remain with the end customer.

2 Intended use

- Switching and dimming of lighting
- Mounting in appliance box according to DIN 49073
- Operation with suitable cover

3 Product characteristics**Product characteristics**

- Device works according to the leading edge phase control or trailing edge phase control principle
- Automatic or manual setting of the dimming principle suitable for the load
- Display of the set operating mode by means LED
- Operation without neutral conductor possible
- Switch-on via bulb-preserving soft start
- Switch on with last saved brightness or saved switch-on brightness
- Switch-on brightness can be saved permanently
- Minimum brightness can be saved permanently
- Connection of extensions possible
- Electronic short-circuit protection with permanent switch-off after 7 seconds at the latest
- Electronic over-temperature protection
- Hotel card function

 Power extension possible by means of power boosters.

4 Operation**Switching light or adjusting brightness**

Operation on the main device or a rotary dimmer extension is identical.

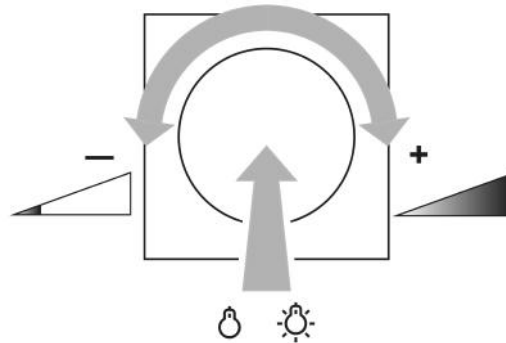

Figure 1: Switching light or adjusting brightness

- Press the setting knob briefly: Light switches on or off (Figure 1).
- Turn the setting knob quickly: Brightness is changed quickly (Figure 1).
- Turn the setting knob slowly: Brightness is changed slowly (Figure 1).

Switching the light on at minimum or maximum brightness

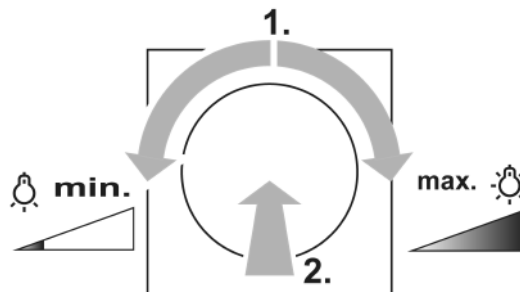

Figure 2: Switching on the light at minimum or maximum brightness

- Turn the setting knob by a quarter turn, then press the setting knob briefly: Light switches on at minimum brightness or maximum brightness (Figure 2).

Save switch-on brightness

- Adjust the brightness.
- Press the setting knob for longer than 4 seconds.
Switch-on brightness is saved. The lighting switches briefly off and on again as confirmation.

Delete switch-on brightness

- Press the setting knob briefly: Light switches on at the saved switch-on brightness.
- Press the setting knob for longer than 4 seconds.
The switch-on brightness is deleted. Switching on takes place at the last brightness value set. For confirmation, the light is switched off briefly and switched on again.

Operation using 2-wire or 3-wire extension with button cover or push-button

- Press briefly: Light switches on or off.
- Press long with the light switched off: Switch on at minimum brightness.
- Press long with the light switched on: Set brightness. The dimming operation stops at the appropriate end value.

i Push-button: The dimming direction is changed with each new long actuation.

- Press the button cover over the entire surface for longer than 4 seconds with the light switched on:
Save switch-on brightness. The lighting switches briefly off and on again as confirmation.

- i On saving the same brightness again, the switch-on brightness is deleted. Switching on takes place at the last brightness value set. For confirmation, the light is switched off briefly and switched on again.
- i Push-button: Switch-on brightness cannot be saved or deleted.

5 Information for electrically skilled persons

5.1 Fitting and electrical connection



DANGER!

Mortal danger of electric shock.

Disconnect the device. Cover up live parts.

Fitting and electrical connection

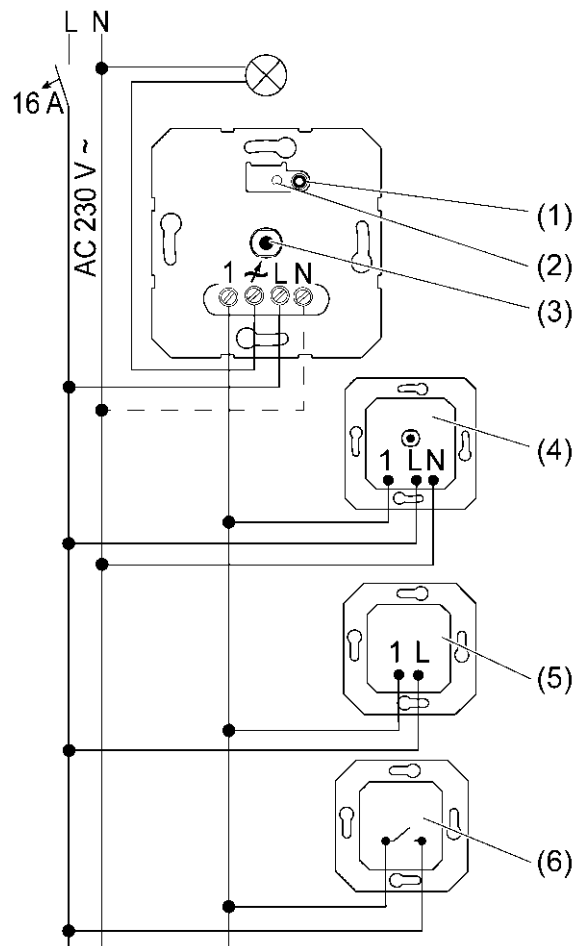

Figure 3: Connection diagram with optional extensions

- (1) Button **Dimm-Mode**
- (2) Display LED of the dimming principle
- (3) Rotary axle
- (4) Rotary dimmer, 3-wire extension
- (5) 2-wire extension
- (6) Push-button, NO contact

- i** Connect 600 Watt LED lamps or compact fluorescent lamps at most per 16 ampere circuit breaker. When connecting transformers, observe the data of the transformer manufacturer.
- i** Our dimmers take into account the different electronic characteristics of most LED lamps found on the market. However, it cannot be guaranteed that in individual cases the desired results may not be achieved.

Operation without neutral conductor possible.

Only connect illuminated push buttons if they have a separate N terminal.

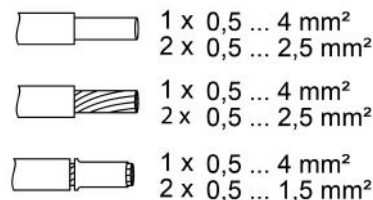

Figure 4: Clampable conductor cross-section

- i** The light can be switched by briefly pressing the **Dimm-Mode** button (1).

Reset the overheating protection / short-circuit protection

If the electronic overheating or short-circuit protection has been activated, separate the dimmer from the grid.

5.2 Commissioning

Operating mode: Universal, R,L,C,LED (factory setting)

- Automatic calibration to the load, dimming principle, trailing edge phase control, leading edge phase control or LED leading edge phase control

Operating mode: LED trailing edge phase control, LED \triangleleft

- Loads can be dimmed according to the trailing edge phase control principle.

- i** The connection of inductive transformers is not permitted.

Operating mode: LED leading edge phase control, LED \triangle

- Loads can be dimmed according to the leading edge phase control principle.

- i** The connection of inductive transformers is not permitted.

Setting operating mode and minimum brightness

Precondition: Load is switched off.

- Press the button **Dimm-Mode** (1) until LED (2) lights up.

LED	Dimm-Mode
GN (grün, green)	R,L,C,LED
RD (rot, red)	LED \triangleleft
BU (blau, blue)	LED \triangle

Figure 5: Assignment of LED colour to dimming principle

- Keep briefly pressing button **Dimm-Mode** (1) until the necessary operating mode is selected.
The LED (2) lights up in the colour of the selected operating mode (Figure 5).
- Press the button **Dimm-Mode** (1) for longer than 1 second and keep it pressed.
LED (2) flashes. Light switches on at the lowest brightness and slowly becomes brighter.

- i** When changing the operating mode to universal, the calibration to the load is first performed. Keep the **Dimm-Mode** button (1) pressed.
- i** In the lowest dimming position, a lamp light must be visible.
 - Once the desired minimum brightness is reached, release the button **Dimm-Mode** (1). LED (2) lights up, operating mode and minimum brightness are set.
 - Optionally change the minimum brightness again: Press the button **Dimm-Mode** (1) for longer than 1 second. Light switches again to the lowest brightness and slowly becomes brighter.
 - Save the settings: Press the button **Dimm-Mode** (1) for less than 1 second or do not press for 30 seconds. The LED (2) goes out.

Switching the hotel card function on or off

Hotel card function, after mains voltage return the dimmer switches on the light with the stored switch-on brightness. Only the operating modes LED trailing edge phase control or LED leading edge phase control are available.

Precondition: Load is switched off.

- Press and hold down the rotary axle (3) until the setting was made.
 - Press the **Dimm-Mode** button (1) for more than 4 seconds. LED (2) flashes green or red.
 - Press button **Dimm-Mode** (1) briefly. LED (2) flashes red. The hotel card function is switched on. LED (2) flashes green. The hotel card function is switched off.
 - Release the rotary axle (3). The setting is saved. For confirmation, the light is briefly switched on and switched off again.
- i** If the Universal operating mode was set before the hotel card function was switched on, the system automatically switches to LED trailing edge phase control or LED leading edge phase control. If the LED trailing edge phase control or LED leading edge phase control operating mode was set, it is retained. If the hotel card function is switched off, the last set operating mode is retained.

6 Technical data

Rated voltage	AC 230 V~
Mains frequency	50 / 60 Hz
Standby power	approx. 0.35 W
Power loss	approx. 4 W
Ambient temperature	-5 ... +45 °C
Connected load at 25°C (Figure 6)	







			
			
W 20...420	W/VA 20...420	W 3...100	W/VA 20...100

Figure 6

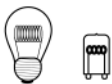
i Operating mode **LED** : Max. connected load for LED lamps typ. 3 ... 400 W, electronic transformers with LV-LED typ. 20 ... 200 W.

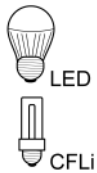
Mixed load

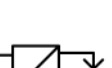
ohmic-capacitive	20 ... 420 W
capacitive-inductive	not permitted
ohmic-inductive	20 ... 420 VA
Ohmic and HV LED	typ. 3 ... 100 W
Ohmic and compact fl lamp.	typ. 3 ... 100 W

i Power specifications including transformer dissipation.

i Operate inductive transformers with at least 85% nominal load in the Universal operating mode.

i Ohmic-inductive mixed load: Max. 50% proportion of ohmic load. Otherwise, an incorrect measurement is possible.

i Operation without neutral conductor: Minimum load 50 W. Does not apply to loads with HV-LED and compact fluorescent lamps.

Power reduction

per 5 °C in excess of 25 °C	-10%
when installed in wooden or dry construction walls	-15%
when installed in multiple combinations	-20%

Power boosters

see power booster instructions

Number of extension units

3-wire, rotary dimmer extension	10
2-wire, push-button	unlimited

Total line length

pwr cable	max. 100 m
Extension	max. 100 m

7 Troubleshooting

Connected LED lamps or compact fluorescent lamps switch off in the lowest dimming position or flicker

Cause: The set minimum brightness is too low.

Increase minimum brightness.

Connected lamps do not switch on in the lowest dimming position or only after a delay

Cause: The set minimum brightness is too low.

Increase minimum brightness.

Connected LED lamps or compact fluorescent lamps flicker or buzz, no correct dimming possible, device buzzes

Cause 1: Lamps are not dimmable.

Check manufacturer's instructions.

Exchange lamps for another type.

Cause 2: Operating mode (dimming principle) and lamps do not optimally match.

Check operation in another operating mode, reduce connected load as well if necessary.

Set the operating mode manually.

Exchange lamps for another type.

Cause 3: Dimmer is connected without neutral conductor.

Connect neutral conductor if possible, otherwise exchange lamp for another type.

Connected LED lamps or compact fluorescent lamps in the lowest dimming position are too bright; dimming range is too small

Cause 1: The set minimum brightness is too high.

Reduce minimum brightness.

Cause 2: Operating mode (dimming principle) does not optimally match the connected HV-LED lamps.

Check operation in another operating mode, reduce connected load as well if necessary.
Set the operating mode manually.

Exchange HV-LED lamps for another type.

The dimmer switches the load off briefly and then on again.

Cause: short-circuit protection has tripped but now there is no longer a fault.

The dimmer has switched off and the load cannot be switched on again

Cause 1: overheating protection has tripped.

Disconnect dimmer from mains by switching off circuit breaker.

LED trailing edge phase control: Reduce the connected load. Exchange lamps for another type.

LED leading edge phase control: Reduce the connected load. Check operation in the LED trailing edge phase control setting. Exchange lamps for another type.

Let dimmer cool down for at least 15 minutes.

Switch circuit breakers and dimmer on again.

Cause 2: Surge protection has triggered.

LED trailing edge phase control: Check operation in the LED leading edge phase control setting, reduce connected load as well if necessary.

Exchange lamps for another type.

Cause 3: short-circuit protection has tripped.

Disconnect dimmer from mains by switching off circuit breaker.

Eliminate short-circuit.

Switch circuit breakers and dimmer on again.

i Short-circuit protection is not based on a conventional fuse, no metallic separation of the operational current.

Cause 4: load failure.

Check load, replace light bulb. For inductive transformers, check primary fuse.

LED lamp is dimly lit when dimmer is switched off

Cause: LED lamp is not suitable for this dimmer.

Use a compensation module, see accessories.

Use another type of LED lamp or an LED lamp of another manufacturer.

8 Accessories

Compensation module LED

Order no. 2375 00

9 Warranty

The warranty is provided in accordance with statutory requirements via the specialist trade. Please submit or send faulty devices postage paid together with an error description to your responsible salesperson (specialist trade/installation company/electrical specialist trade). They will forward the devices to the Gira Service Center.

Gira
Giersiepen GmbH & Co. KG
Elektro-Installations-
Systeme

Industriegebiet Mermbach
Dahlienstraße
42477 Radevormwald

Postfach 12 20
42461 Radevormwald

Deutschland

Tel +49(0)21 95 - 602-0
Fax +49(0)21 95 - 602-191

www.gira.de
info@gira.de