

SPARTA MLP6501

MILAGRO®

Brand that inspires

EKO-LIGHT Sp. z o.o. Sp. k. ☎ +48 666 503 333
ul. Paszcza 19, ✉ biuro@eko-light.com
42-209 Częstochowa
www.eko-light.com

01

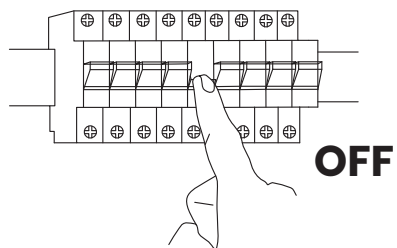

02

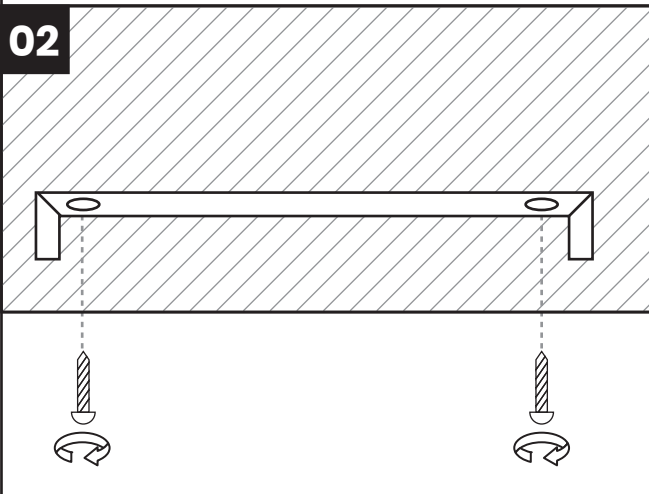

03

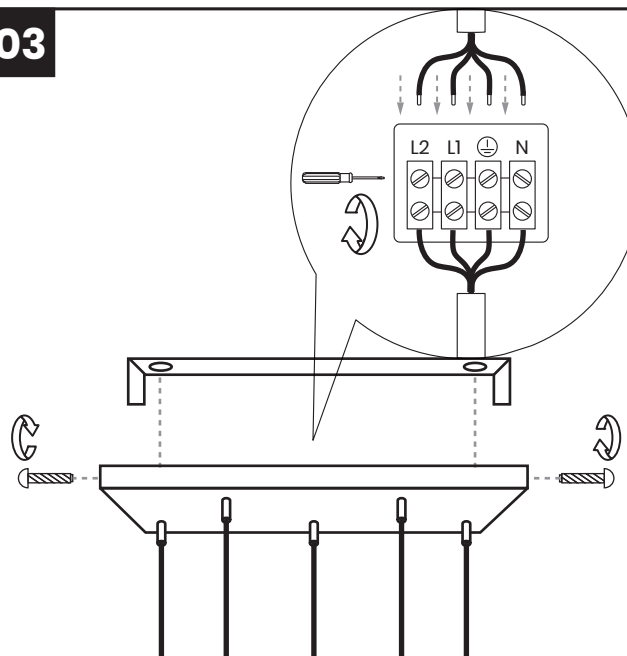

04

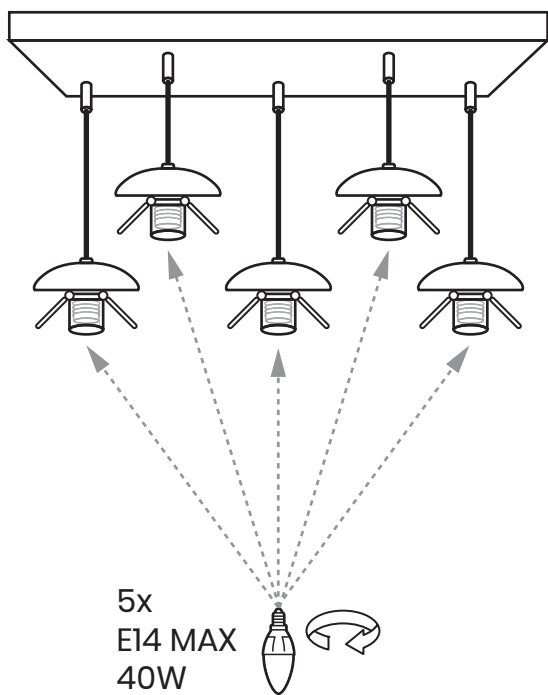

05

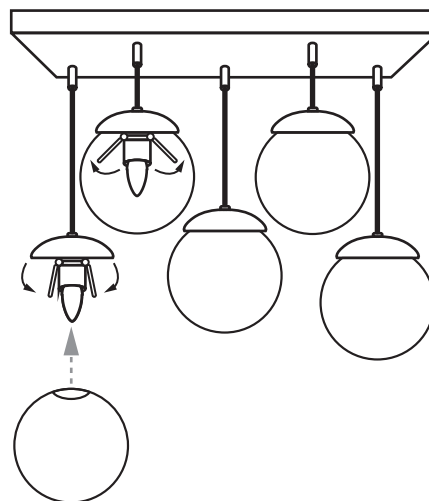

07

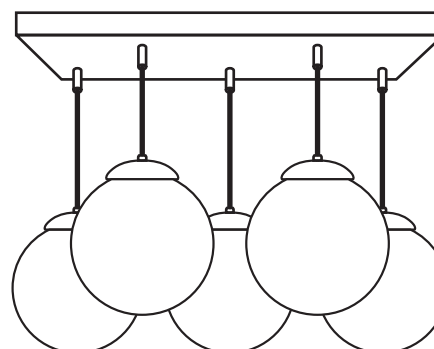

06

