

## DERATO

### Oprawa ścienna-sufitowa



HIGH  
quality  
finish

MODERN  
design

[V] 220-240 AC	[Hz] 50		E14		IP 20	
 5÷25		 350	 110		 0,5m	CE
EAC	UK CA					

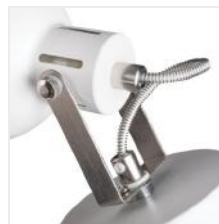
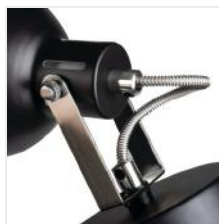

### DERATO EL-10 B-SR



DERATO EL-10 B-SR	<b>35640</b>	max 8	czarny / srebrny
DERATO EL-10 W-SR	<b>35641</b>	max 8	biały / srebrny
DERATO EL-2I B-SR	<b>35642</b>	2x max 8	czarny / srebrny
DERATO EL-2I W-SR	<b>35643</b>	2x max 8	biały / srebrny
DERATO EL-3O B-SR	<b>35644</b>	3x max 8	czarny / srebrny
DERATO EL-3O W-SR	<b>35645</b>	3x max 8	biały / srebrny
DERATO EL-4I B-SR	<b>35646</b>	4x max 8	czarny / srebrny
DERATO EL-4I W-SR	<b>35647</b>	4x max 8	biały / srebrny

Nowa seria opraw Kanlux DERATO kształtem nawiązuje do stylistyki RETRO. To lampy w dwóch kolorach: białym i czarnym, które posiadają od 1 do 4 punktów świetlnych. Jednopunktowe Kanlux DERATO z powodzeniem spełni również rolę kinkietu. Duże klosze tych opraw to także duże możliwości w zastosowaniu różnych źródeł światła z trzonkiem E14 (max.8W). W oprawach Kanlux DERATO zastosowano szybkozłączkę dla wygodnego i szybkiego montażu. Dodatkowym atutem jest bardzo szeroka możliwość skierowania klosza w dowolne miejsce (dwie osie obrotu 350 i 110 stopni).

- Materiał obudowy: stop aluminium

## DERATO

Oprawa ścienna-sufitowa



DERATO EL-10 B-SR



DERATO EL-10 W-SR



DERATO EL-21 B-SR

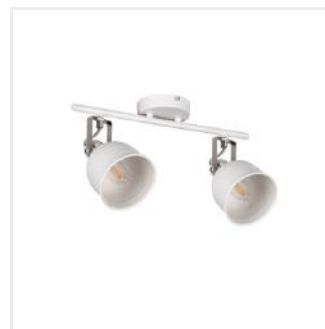

DERATO EL-21 W-SR



DERATO EL-30 B-SR



DERATO EL-30 W-SR



DERATO EL-41 B-SR

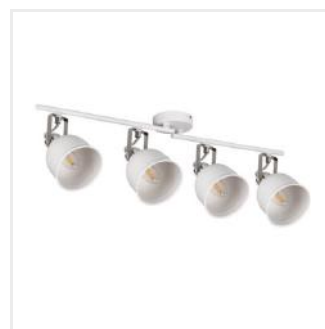

DERATO EL-41 W-SR

## DERATO

### Oprawa ścienna-sufitowa

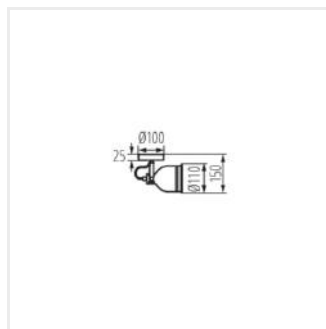

DERATO EL-10

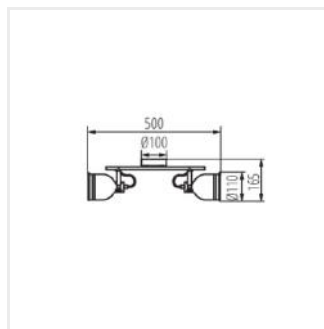

DERATO EL-21

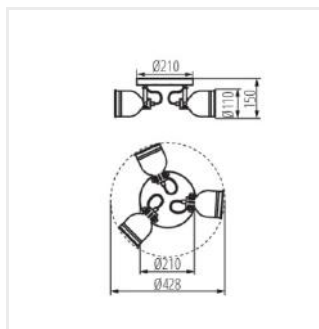

DERATO EL-30

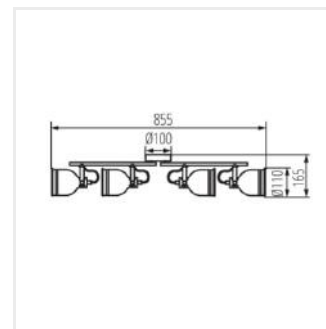

DERATO EL-41